

Memorex®

Is it live or is it Memorex?™

MKS8590

User's Guide

Karaoke/Audio Recording System
with 5.5" B&W Monitor, USB Jack &
SD/MMC Memory Card Slot

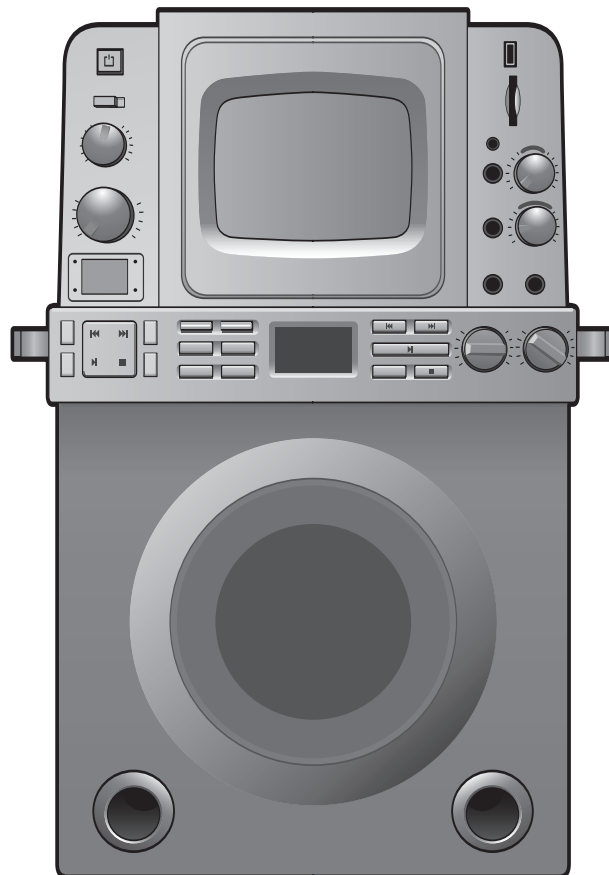

**Before operating this product,
please read these instructions completely.**



Dear Customer,

Please read this manual thoroughly before operating the unit to become more familiar with it and obtain the performance that will bring you continued enjoyment for many years. Keep these instructions handy for future reference.

PLEASE KEEP ALL PACKAGING MATERIAL FOR AT LEAST 90 DAYS IN CASE YOU NEED TO RETURN THIS PRODUCT TO YOUR PLACE OF PURCHASE OR MEMOREX.

For future reference, record the serial number of the unit printed on the rear of the cabinet.

Serial Number _____

	CAUTION RISK OF ELECTRIC SHOCK DO NOT OPEN	
CAUTION: TO REDUCE THE RISK OF ELECTRIC SHOCK, DO NOT REMOVE COVER (OR BACK). NO USER-SERVICEABLE PARTS INSIDE. REFER SERVICING TO QUALIFIED SERVICE PERSONNEL. This Caution Marking and Rating Label are located at the bottom enclosure of the unit.		



DANGEROUS VOLTAGE:

The lightning flash with arrowhead symbol within an equilateral triangle is intended to alert the user to the presence of uninsulated dangerous voltage within the product's enclosure that may be of sufficient magnitude to constitute a risk of electric shock to persons.



ATTENTION:

The exclamation point within an equilateral triangle is intended to alert the user to the presence of important operating and maintenance (servicing) instructions in the literature accompanying the appliance.

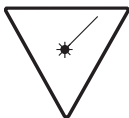

DANGER:

Invisible and hazardous laser radiation when open and interlock failed or defeated. Avoid direct exposure to beam.

FCC WARNING:
This equipment may generate or use radio frequency energy. Changes or modifications to this equipment may cause harmful interference unless the modifications are expressly approved in the instruction manual. The user could lose the authority to operate this equipment if an unauthorized change or modification is made.

LASER SAFETY: This unit employs a laser. Only qualified service personnel should attempt to service this device due to possible eye injury.
CAUTION: USE OF CONTROLS, ADJUSTMENTS OR PERFORMANCE PROCEDURE HEREIN MAY RESULT IN HAZARDOUS RADIATION EXPOSURE.

INFORMATION
This equipment has been tested and found to comply with the limits for a Class B digital device, pursuant to Part 15 of the FCC Rules. These limits are designed to provide reasonable protection against harmful interference in a residential installation. This equipment generates, uses and can radiate radio frequency energy and, if not installed and used in accordance with the instructions, may cause harmful interference to radio communications. However, there is no guarantee that interference will not occur in a particular installation. If this equipment does cause harmful interference to radio or television reception, which can be determined by turning the equipment off and on, the user is encouraged to try to correct the interference by one or more of the following measures:

- Reorient or relocate the receiving antenna.
- Increase the separation between the equipment and receiver.
- Connect the equipment into an outlet on a circuit different from that to which the receiver is connected.
- Consult the dealer or an experienced radio/TV technician for help.

WARNING: TO PREVENT FIRE OR SHOCK HAZARD, DO NOT EXPOSE THIS UNIT TO RAIN OR MOISTURE.

SURGE PROTECTORS:
It is recommended to use a surge protector for AC connection. Lightning and power surges ARE NOT covered under warranty for this product.

ATTENTION:
POUR ÉVITER LES CHOC ÉLECTRIQUES, INTRODUIRE LA LAME LA PLUS LARGE DE LA FICHE DANS LA BORNE CORRESPONDANTE DE LA PRISES ET POUSSER JUSQU'AU FOND.

This Class B digital apparatus complies with Canadian ICES-003.
Cet appareil numérique de la classe B est conforme à la norme NMB-003 du Canada.

Dear Customer:

Selecting fine audio equipment such as the unit you've just purchased is only the start of your musical enjoyment. Now it's time to consider how you can maximize the fun and excitement your equipment offers. This manufacturer and the Electronic Industries Association's Consumer Electronics Group want you to get the most out of your equipment by playing it at a safe level. One that lets the sound come through loud and clear without annoying blaring or distortion-and, most importantly, without affecting your sensitive hearing.

Sound can be deceiving. Over time your hearing "comfort level" adapts to higher volumes of sound. So what sounds "normal" can actually be loud and harmful to your hearing. Guard against this by setting your equipment at a safe level BEFORE your hearing adapts.

To establish a safe level:

- Start your volume control at a low setting.
- Slowly increase the sound until you can hear it comfortably and clearly, and without distortion.

Once you have established a comfortable sound level:

- Set the dial and leave it there.

Taking a minute to do this now will help to prevent hearing damage or loss in the future. After all, we want you listening for a lifetime.

We Want You Listening For A Lifetime

Used wisely, your new sound equipment will provide a lifetime of fun and enjoyment. Since hearing damage from loud noise is often undetectable until it is too late, this manufacturer and the Electronic Industries Association's Consumer Electronics Group recommend you avoid prolonged exposure to excessive noise. This list of sound levels is included for your protection.

Decibel

<u>Level</u>	<u>Example</u>
30	Quiet library, soft whispers
40	Living room, refrigerator, bedroom away from traffic
50	Light traffic, normal conversation, quiet office
60	Air conditioner at 20 feet, sewing machine
70	Vacuum cleaner, hair dryer, noisy restaurant
80	Average city traffic, garbage disposals, alarm clock at two feet

THE FOLLOWING NOISES CAN BE DANGEROUS UNDER CONSTANT EXPOSURE:

90	Subway, motorcycle, truck traffic, lawn mower
100	Garbage truck, chain saw, pneumatic drill
120	Rock band concert in front of speakers, thunderclap
140	Gunshot blast, jet engine
180	Rocket launching pad

Information courtesy of the Deafness Research Foundation.



SAFETY INSTRUCTIONS

Before using the unit, be sure to read all operating instructions carefully. Please note that these are general precautions and may not pertain to your unit. For example, this unit may not have the capability to be connected to an outdoor antenna.

1. READ INSTRUCTIONS

All the safety and operating instructions should be read before the product is operated.

2. RETAIN INSTRUCTIONS

The safety and operating instructions should be retained for future reference.

3. HEED WARNINGS

All warnings on the product and in the operating instructions should be adhered to.

4. FOLLOW INSTRUCTIONS

All operating and use instructions should be followed.

5. CLEANING

Unplug this product from the wall outlet before cleaning. Do not use liquid cleaners or aerosol cleaners. Use a dry cloth for cleaning.

6. ATTACHMENTS

Do not use attachments not recommended by the product's manufacturer as they may cause hazards.

7. WATER AND MOISTURE

Do not use this product near water—for example: near a bathtub, washbowl, kitchen sink or laundry tub; in a wet basement; or near a swimming pool.

8. ACCESSORIES

Do not place this product on an unstable cart, stand, tripod, bracket or table. The product may fall, causing serious injury and serious damage to the product. Use only with a cart, stand, tripod, bracket or table recommended by the manufacturer or sold with the product. Any mounting of the product should follow the manufacturer's instructions, and should use a mounting accessory recommended by the manufacturer.

PORTABLE CART WARNING
(symbol provided by RETAC)



8A. An appliance and cart combination should be moved with care. Quick stops, excessive force and uneven surfaces may cause the appliance and cart combination to overturn.

9. VENTILATION

Slots and openings in the cabinet and in the back or bottom are provided for ventilation, to ensure reliable operation of the product and to protect it from overheating. These openings must not be blocked or covered. The openings should never be blocked by placing the product on a bed, sofa, rug or other similar surface. This product should never be placed near or over a radiator or heat source. This product should not be placed in a built-in installation such as a bookcase or rack unless proper ventilation is provided or the manufacturer's instructions have been adhered to.

10. POWER SOURCES

This product should be operated only from the type of power source indicated on the marking label. If you are not sure of the type of power supply to your home, consult your appliance dealer or local power company. For products intended to operate from battery power, or other sources, refer to the operating instructions.

11. GROUNDING OR POLARIZATION

This product is equipped with a polarized alternating-current line plug (a plug having one blade wider than the other). This plug will fit into the power outlet only one way. This is a safety feature. If you are unable to insert the plug fully into the outlet, try reversing the plug. If the plug should still fail to fit, contact your electrician to replace your obsolete outlet. Do not defeat the safety purpose of the polarized plug.

12. POWER-CORD PROTECTION

Power-supply cords should be routed so that they are not likely to be walked on or pinched by items placed upon or against them, paying particular attention to cords at plugs, convenience receptacles, and the point where they exit from the appliance.

13. LIGHTNING

To protect your product from a lightning storm, or when it is left unattended and unused for long periods of time, unplug it from the wall outlet and disconnect the antenna or cable system. This will prevent damage to the product due to lightning and power-line surges.

14. POWER LINES

An outside antenna system should not be located in the vicinity of overhead power lines or other electric light or power circuits, or where it can fall into such power lines or circuits. When installing an outside antenna system, extreme care should be taken to keep from touching such power lines or circuits as contact with them might be fatal.

15. OVERLOADING

Do not overload wall outlets and extension cords as this can result in a risk of fire or electric shock.

16. OBJECT AND LIQUID ENTRY

Never push objects of any kind into this product through openings as they may touch dangerous voltage points or short out parts that could result in fire or electric shock. Never spill or spray any type of liquid on the product.

17. OUTDOOR ANTENNA GROUNDING

If an outside antenna is connected to the product, be sure the antenna system is grounded so as to provide some protection against voltage surges and built-up static charges. Section 810 of the National Electric Code, ANSI/NFPA 70, provides information with respect to proper grounding of the mast and supporting structure, grounding of the lead-in wire to an antenna discharge product, size of grounding conductors, location of antenna discharge product, connection to grounding electrodes and requirements for grounding electrodes.

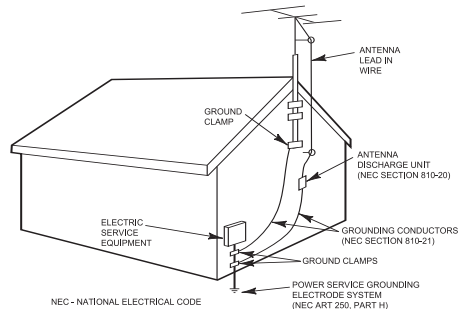

S2898A

EXAMPLE OF ANTENNA GROUNDING AS PER NATIONAL ELECTRICAL CODE

18. SERVICING

Do not attempt to service this product yourself as opening or removing covers may expose you to dangerous voltage or other hazards. Refer all servicing to qualified service personnel.

19. REPLACEMENT PARTS

When replacement parts are required, be sure the service technician uses replacement parts specified by the manufacturer or those that have the same characteristics as the original part. Unauthorized substitutions may result in fire, electric shock or other hazards.

20. SAFETY CHECK

Upon completion of any service or repairs to this product, ask the service technician to perform safety checks to determine that the product is in proper operating condition.

21. WALL OR CEILING MOUNTING

The product should be mounted to a wall or ceiling only as recommended by the manufacturer.

22. DAMAGE REQUIRING SERVICE

Unplug the product from the wall outlet and refer servicing to qualified service personnel under the following conditions:

- When the power-supply cord or plug is damaged.
- If liquid has been spilled or objects have fallen into the product.
- If the product has been exposed to rain or water.
- If the product does not operate normally by following the operating instructions. Adjust only those controls that are covered by the operating instructions, as an adjustment of other controls may result in damage and will often require extensive work by a qualified technician to restore the product to its normal operation.
- If the product has been dropped or the cabinet has been damaged.
- When the product exhibits a distinct change in performance—this indicates a need for service.

23. HEAT

The product should be situated away from heat sources such as radiators, heat registers, stoves or other products (including amplifiers) that produce heat.

24. NOTE TO CATV SYSTEM INSTALLER

This reminder is provided to call the CATV system installer's attention to Article 820-40 of the NEC that provides guidelines for proper grounding and, in particular, specifies that the cable ground shall be connected to the grounding system of the building, as close to the point of cable entry as practical.

LOCATION OF CONTROLS

FRONT

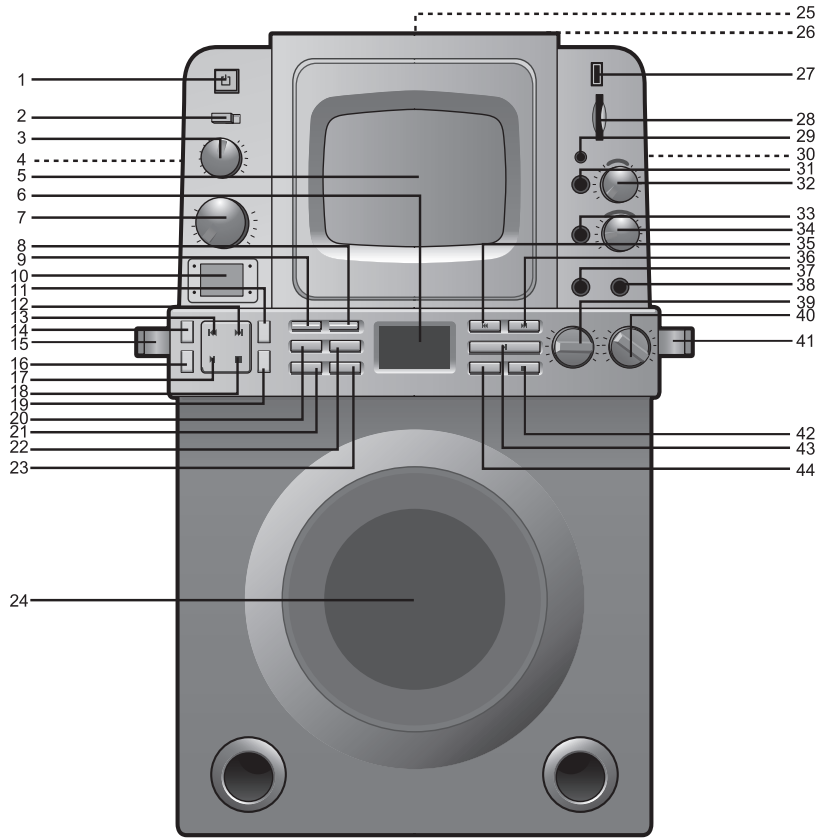

1. POWER Button
2. MONITOR Switch (ON/OFF)
3. ECHO Control
4. Carrying Handle (Side of Unit)
5. Monitor
6. USB-SD/MMC Display
7. MASTER VOLUME Control
8. REC (Record) SYNC Button
9. REC (Record) Button
10. CD+G Display with REPEAT Indicator CD+G Indicator
11. VOCAL Button
12. CD+G SKIP/SEARCH ►► Button
13. CD+G SKIP/SEARCH ◄◄ Button
14. CD+G PROG. (PROGRAM) Button
15. MIC Holder (Side of Unit)
16. CD+G REPEAT Button
17. CD+G PLAY/PAUSE (►||) Button
18. CD+G STOP (■) Button
19. VOCAL AUTO Button
20. DIR (Directory) - Button
21. DISPLAY Button
22. DIR (Directory) + Button
23. DELETE Button
24. Speaker
25. CD Compartment (Top of Unit)
26. OPEN/CLOSE Area (Top of Unit)
27. USB Jack
28. SD/MMC Memory Card Slot
29. Headphones Jack
30. Carrying Handle (Side of Unit)
31. GUITAR Jack
32. GUITAR VOLUME Control
33. KEYBOARD Jack
34. KEYBOARD VOLUME Control
35. SKIP/SEARCH ◄◄ Button (for USB & SD/MMC card)
36. SKIP/SEARCH ►► Button (for USB & SD/MMC card)
37. MIC 1 Jack
38. MIC 2 Jack
39. MIC 1 VOLUME Control
40. MIC 2 VOLUME Control
41. MIC Holder (Side of Unit)
42. STOP (■) Button (for USB & SD/MMC card)
43. PLAY/PAUSE (►||) Button (for USB & SD/MMC card)
44. REPEAT Button (for USB & SD/MMC card)

REAR

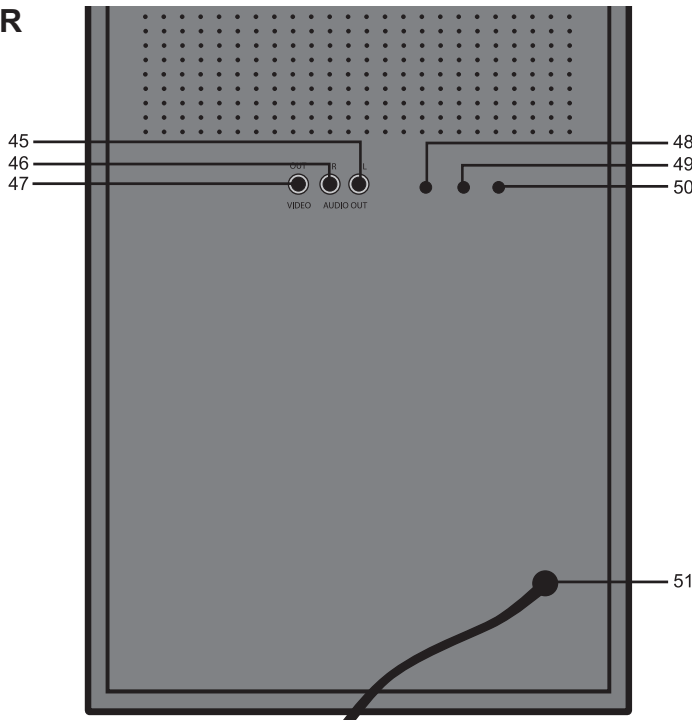

45. AUDIO OUT Left Jack
46. AUDIO OUT Right Jack
47. VIDEO OUT Jack
48. V-HOLD Control
49. BRIGHT Control
50. CONTRAST Control
51. AC Cord

POWER SOURCE

AC:

Use the AC polarized line cord included with the unit for operation on AC power. Insert into a conveniently located AC outlet having 120V, 60Hz.

NOTE: The AC plug supplied with the unit is polarized to help minimize the possibility of electric shock. If the AC plug does not fit into a nonpolarized AC outlet, do not file or cut the wide blade. It is the user's responsibility to have an electrician replace the obsolete outlet.

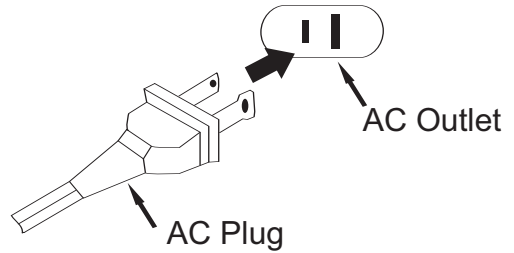

OPTIONAL CONNECTIONS

If you are using special CD+G (Graphics) discs in this Karaoke system, you can connect this unit to an external television set in order to see the On-Screen Graphics that are recorded on CD+G Karaoke discs on an external TV, as well as the built-in monitor. Use the MONITOR switch to turn the built-in monitor ON or OFF; the external TV will automatically display the On-Screen Graphics when connected.

The video cable has yellow RCA type plugs on each end. Please note that your TV set must have an RCA type Video Input jack in order to view the CD+G lyrics on your TV screen. You cannot connect this portable Karaoke system to your TV's coaxial antenna terminal.

Also note that On-Screen Graphics are only available on special Karaoke compact discs that bear the CD+G mark.



Many newer TV sets have a set of Video and Stereo Audio jacks on the front panel for quick and easy connections without having to turn the TV set to gain access to the jacks on the back panel. If your TV set has such front panel A/V jacks, we suggest that you use those jacks to connect your portable Karaoke system.

After connecting the Video Out jack on this Karaoke system to the Video In jack on your TV with the included video cable, you have the following three choices:

1. Listen to the sound from the built-in speaker in this Karaoke system. In this case, no external audio connections are required, just the video connection.
2. If your TV has stereo audio input jacks, you can connect the Audio Out jacks on the back of this unit to the Audio In jacks on your TV. In this case, the lyrics from the CD+G disc will appear on your TV screen and/or monitor and the sound from the disc will be heard from your TV speakers.

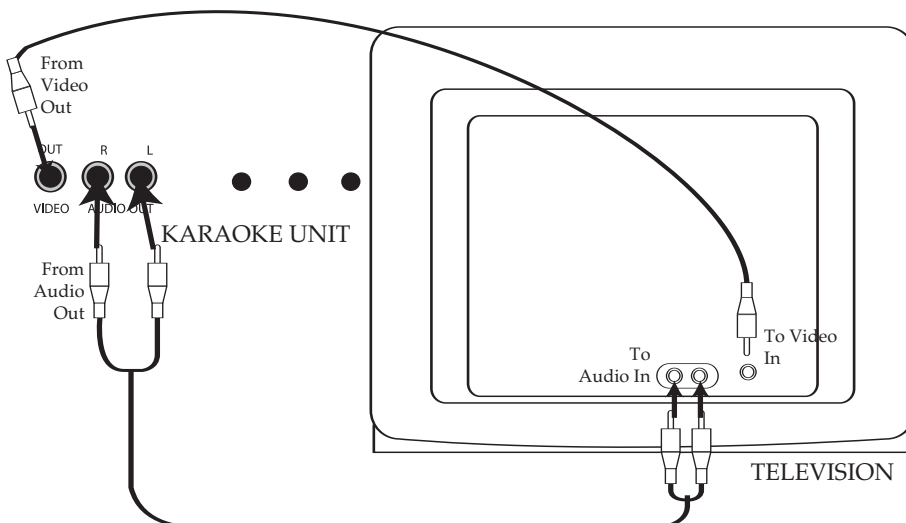

OPTIONAL CONNECTIONS (CONTINUED)

Note: If you have a mono TV with only one Audio In jack, you may have to purchase a “Y” adapter (stereo to mono) at your local electronics accessories store in order to combine the Left and Right stereo channels from this portable Karaoke system to a single mono channel for connection to your mono TV.

3. You can connect the Audio Out jacks from this portable Karaoke system to the Aux In or Audio In jacks of your home stereo system to hear the sound through your home stereo speakers. Follow the instructions for your home stereo system to select the device connected to the external jacks as the audio source.

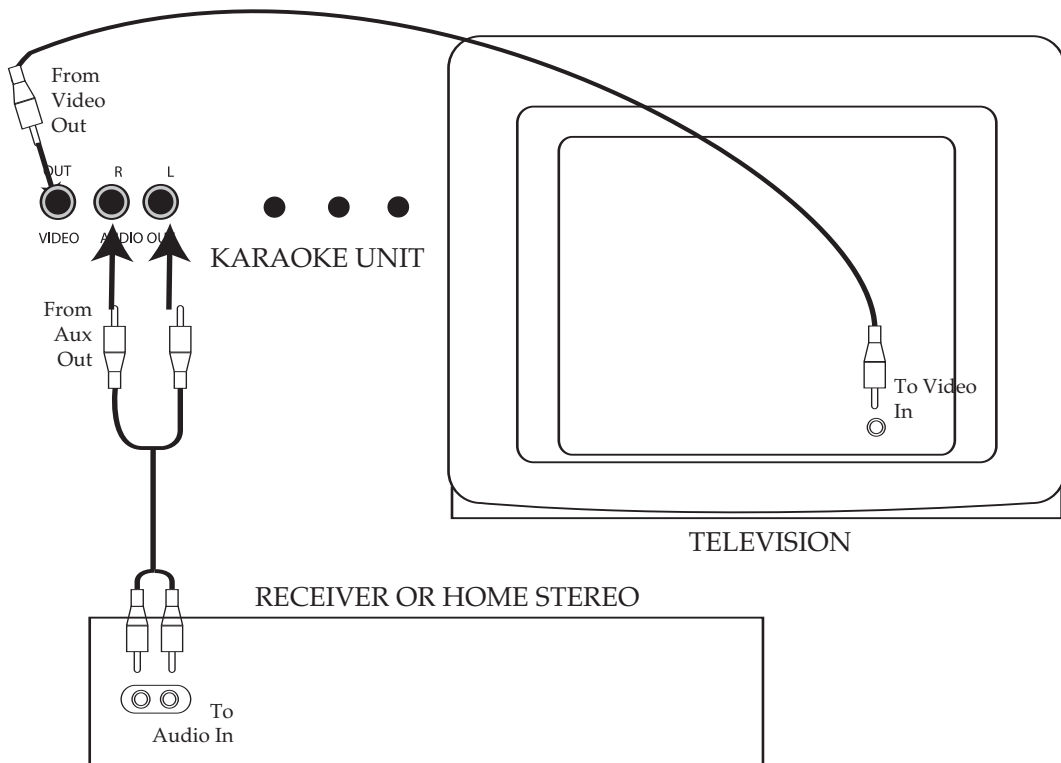

OPERATION

CONNECTING THE MICROPHONE(S)

This unit has two microphone jacks which will allow you to sing along with your favorite songs. Before connecting, make sure the MIC VOLUME controls are set to minimum.

To turn the microphone(s) on, slide the ON/OFF switch(es), located on the side of the microphone(s), to the ON position. To turn the microphone(s) off, slide the ON/OFF switch(es) to the OFF position.

HEADPHONES JACK

For private listening, connect low impedance 3.5mm (32 ohm) stereo headphones (not included) to this jack. The speaker is automatically disconnected when the headphones plug is inserted into the jack.

ECHO CONTROL

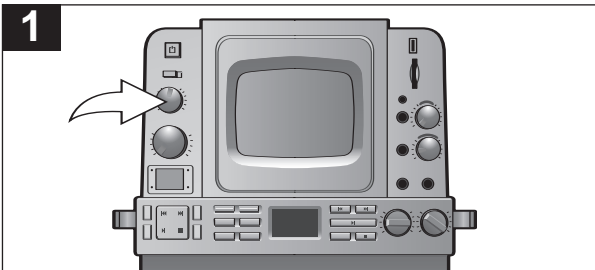

Rotate the ECHO control clockwise to increase the echo or counterclockwise to decrease the echo.

VOCAL AUTO BUTTON

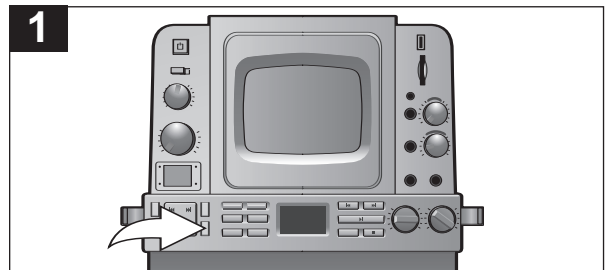

When the Vocal Auto feature is activated, the vocals on a multiplex recording are muted as soon as the singer begins singing into the microphone. When the singer stops singing, the vocals are automatically unmuted. Press the VOCAL AUTO button to activate this feature.

IMPORTANT NOTE: This feature only works with multiplex media.

VOCAL BUTTON

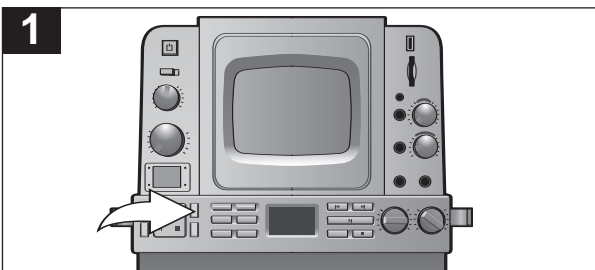

Press this button to control the Left/Right Speaker Channel and Vocal Off. Press once and the display will show "V LEFT" for the Left Channel. Press twice and the display will show "V RIGHT" for the Right Channel. Press three times and the display will show "V OFF" for the balance of both channels.

MONITOR SWITCH

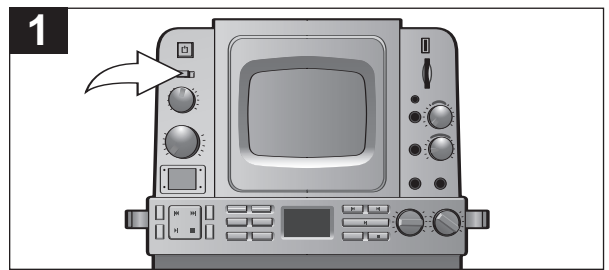

Slide the MONITOR switch to ON and the On-Screen Graphics recorded on the CD+G disc will appear on the monitor.

OPERATION (CONTINUED)

PLAYING COMPACT DISCS

NORMAL PLAYBACK

(For karaoke, please refer to page 12.)

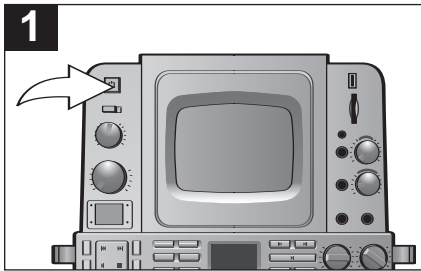

Press the **POWER** button to turn the unit on.

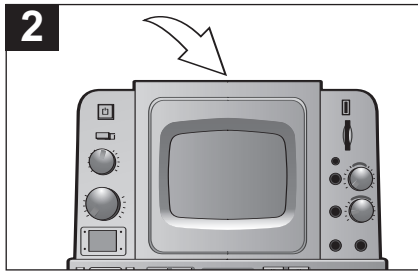

Press the **OPEN/CLOSE** area on the top of the unit to open the CD compartment.

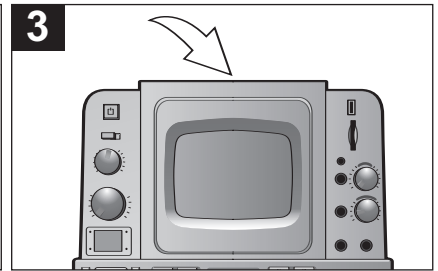

Place a CD in the compartment, with the printed label side facing up and close the CD compartment door.

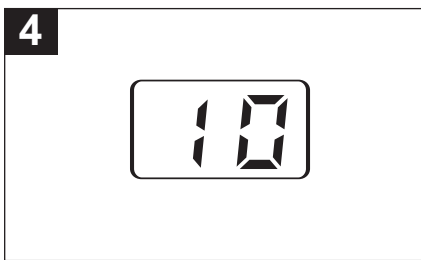

The CD player will read the table of contents on the disc and the total number of tracks on the disc will appear in the CD+G display.

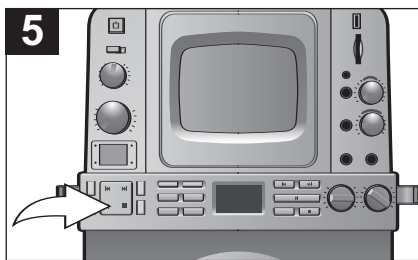

Press the **CD+G PLAY/PAUSE** (▶||) button to begin playback on Track 1; the **PLAY/PAUSE** indicator will light.

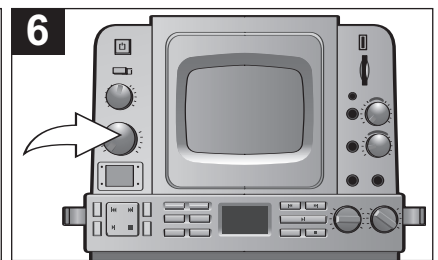

Adjust the **MASTER VOLUME** control as desired. Playback will continue until all of the tracks on the disc have been played.

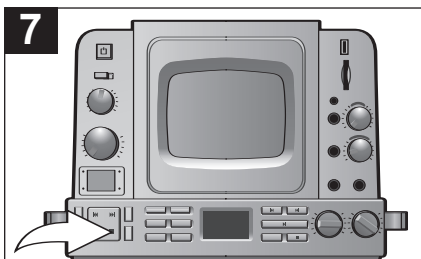

To stop playback before the disc ends, press the **CD+G STOP** (■) button. The disc will stop and the display will show the total number of tracks.

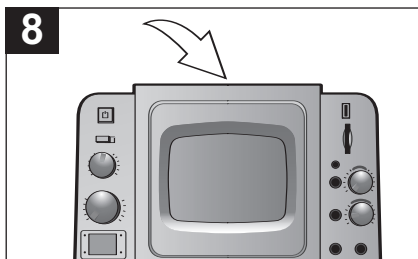

After the last track has been played, the disc stops automatically and the display shows the total number of tracks on the disc. If you are finished listening, press the **OPEN/CLOSE** area on the top of the unit to open the CD compartment.

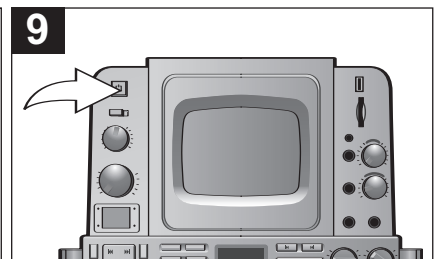

Remove your disc and press the **POWER** button to turn the unit off.

OPERATION (CONTINUED)

CD PAUSE CONTROL

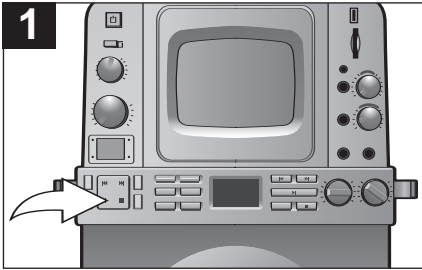

During CD playback, if you wish to pause the disc momentarily, press the CD+G PLAY/PAUSE (▶||) button. Playback stops but the disc continues to spin and the PLAY/PAUSE indicator will blink.

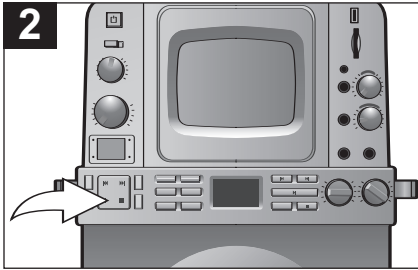

Press the CD+G PLAY/PAUSE (▶||) button again to release pause and resume normal CD playback; the PLAY/PAUSE indicator will light.

TO BEGIN PLAYBACK FROM A SPECIFIC TRACK

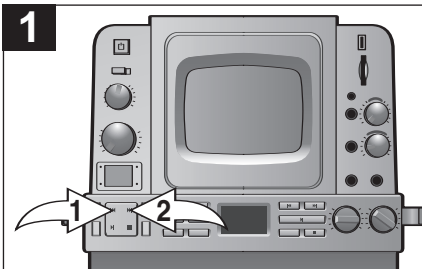

After you insert the disc into the CD player and the total number of tracks appear on the display, you may press either the CD+G SKIP/SEARCH (▶) or (◀) button to select a specific track for playback.

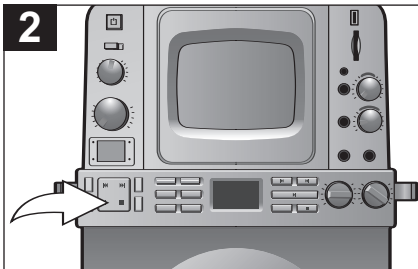

When the desired track number blinks in the display, within five seconds, press the CD+G PLAY/PAUSE (▶||) button. Playback will begin on the track you selected.

FORWARD/REVERSE SKIP TRACK AND HIGH-SPEED MUSIC SEARCH (◀◀/▶▶)

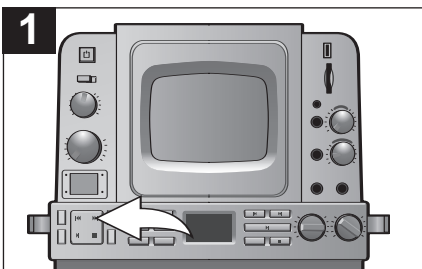

During playback, press the CD+G SKIP/SEARCH (▶) button once to advance the player to the beginning of the next track. Press the CD+G SKIP/SEARCH (▶) button repeatedly to advance the player to higher-numbered tracks.

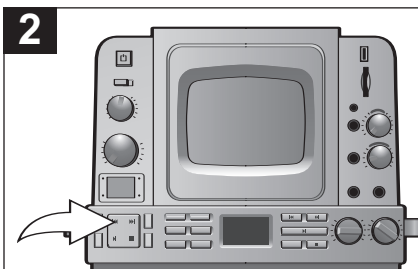

During playback, press the CD+G SKIP/SEARCH (◀) button once to move the player back to the beginning of the current track. Press the CD+G SKIP/SEARCH (◀) button repeatedly to move the player back to lower-numbered tracks.

3

CD ONLY

During playback, depress and hold either the CD+G SKIP/SEARCH (▶) or (◀) button to move the player forward or backward within a track to locate a specific musical passage. The player will move forward or backward at high speed as long as the button is depressed. When you release the CD+G SKIP/SEARCH (▶) or (◀) button, normal playback will resume.

OPERATION (CONTINUED)

REPEAT PLAYBACK

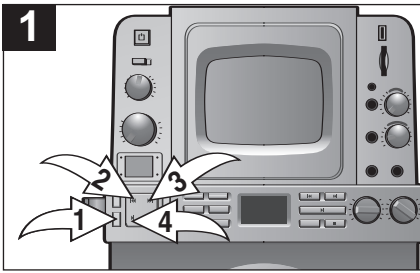

To repeat a single track, while in the Stop mode, press the CD+G REPEAT button ❶ once; the REPEAT indicator will blink. Press the CD+G SKIP/SEARCH ⏪ ❷ or ⏩ ❸ button to select the specific track that you wish to repeat. When the desired track number blinks in the display, within five seconds, press the CD+G PLAY/PAUSE (▶||) button ❹ to begin playback. The specific track you selected will be repeated continuously.

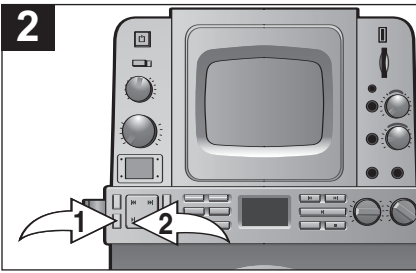

To repeat all of the tracks on a disc continuously, while in the Stop mode, press the CD+G REPEAT button ❶ twice; the REPEAT indicator will light solid. Press the CD+G PLAY/PAUSE (▶||) button ❷ to repeat all tracks.

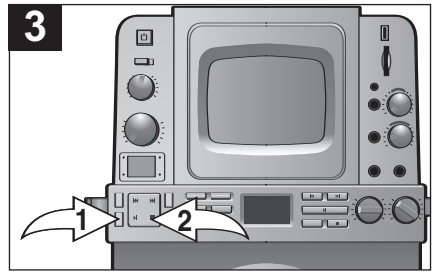

To cancel Repeat Playback, press the CD+G REPEAT button ❶ until the REPEAT indicator goes out. You can also cancel Repeat Playback by pressing the CD+G STOP (■) button ❷.

PROGRAMMED PLAYBACK

The CD player in this unit has a 19 track programmable memory that allows you to program up to 19 tracks on any disc for playback in any desired order. You may program 19 different tracks or you may also program certain tracks to play more than once.

To perform programmed playback, proceed as follows:

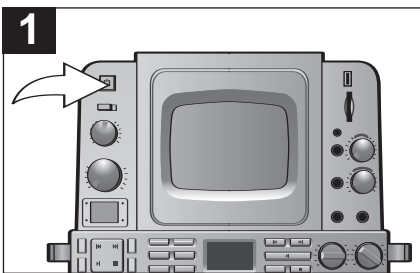

Press the POWER button to turn the unit on.

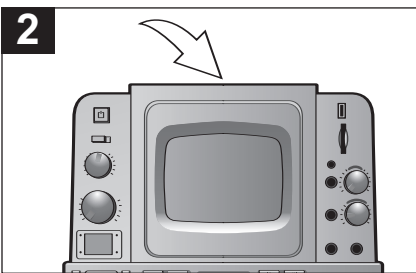

Press the OPEN/CLOSE area on the top of the unit to open the CD compartment. Place a CD in the compartment, with the printed label side facing up and close the CD compartment door.

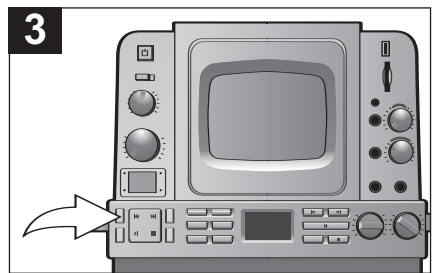

Press the CD+G PROG. button; "0" will blink in the display and the PROG. indicator will blink.

CONTINUED ON THE NEXT PAGE

OPERATION (CONTINUED)

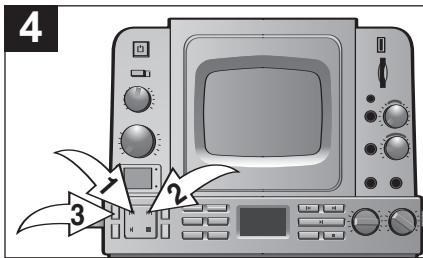

4 Press the CD+G SKIP/SEARCH **⏪ 1** or **⏩ 2** button to select the first track that you wish to program. When the desired track number blinks in the display, press the CD+G PROG. button **3** again.

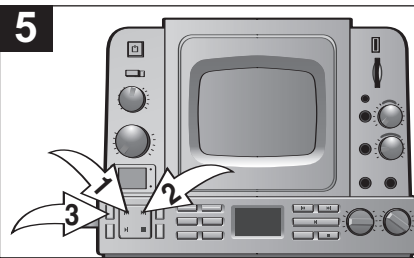

5 Press either the CD+G SKIP/SEARCH **⏪ 1** or **⏩ 2** button to select the next track you wish to program. When the desired track number blinks in the display, press the CD+G PROG. button **3** again.

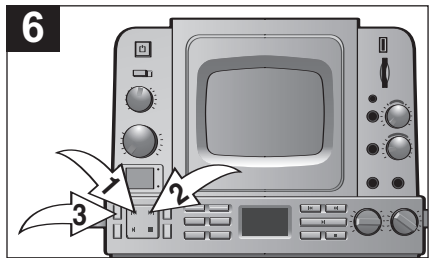

6 Repeat step 5 until you have programmed the desired track numbers into the CD Program Memory. When the memory is full, “- -” will blink in the display.

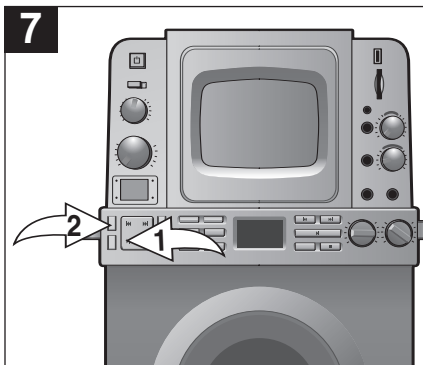

7 Press the CD+G PLAY/PAUSE **▶|| 1** button to begin programmed playback. The PROG. indicator will blink and playback will begin on the first track that you programmed. The player will continue to play all of the tracks that you programmed in the order in which you programmed them. When the last programmed track has been played, the player will stop and the display will again show the total number of tracks on the disc. If you press the CD+G PROG. button **2** and then press the CD+G PLAY/PAUSE **▶|| 1** button again, playback will start on the first track you programmed and will continue until all the programmed tracks have been played.

To clear programmed playback, while in the Stop mode, press the CD+G PROG. button followed by the CD+G STOP **■** button or open the CD compartment door.

To check the programmed tracks, while in the Stop mode, press the CD+G PROG. button repeatedly to view the programmed tracks.

PROGRAMMED REPEAT

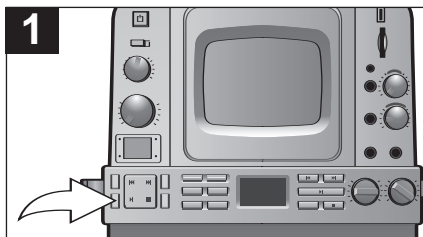

1 It is also possible to use the Program and Repeat functions together to repeat a specific program indefinitely. First, program the tracks you wish to hear in the order you wish to hear them, as described above. Then, press the CD+G REPEAT button twice. The PROGRAM indicator will blink and the REPEAT indicator will light.

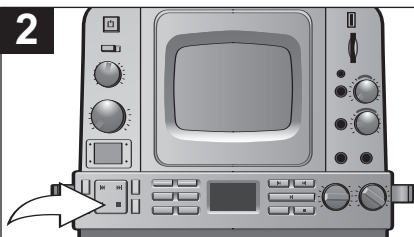

2 Press the CD+G PLAY/PAUSE **▶||** button to begin Programmed Repeat playback. The player will play the tracks you selected in the order in which you programmed them. When the last track in the program has been played, the entire program will begin again.

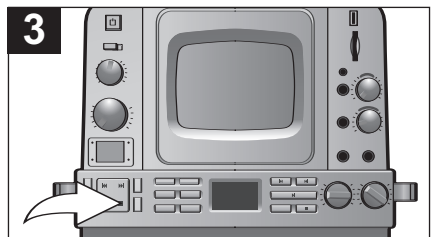

3 Programmed Repeat playback will continue indefinitely until you press the CD+G STOP **■** button or open the CD compartment door.

OPERATION (CONTINUED)

PLAYING A CD+G (COMPACT DISC + GRAPHICS) KARAOKE DISC

You can listen to a CD+G Karaoke disc. CD+G discs combine the recorded music with an additional video track that displays the song lyrics on this monitor and/or an external TV, if connected. As the song plays, the words to be sung are highlighted on most CD+Gs.

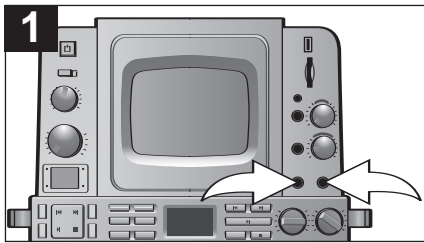

1 Insert a CD+G disc. Insert the microphone(s) into the MIC jack(s). You can connect the unit to a TV or TV and stereo as shown on pages 5-6.

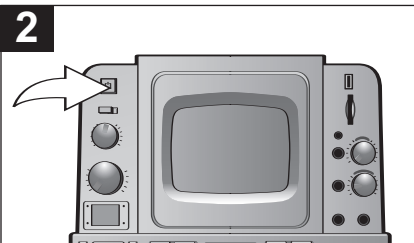

2 Press the POWER button to turn the unit on.

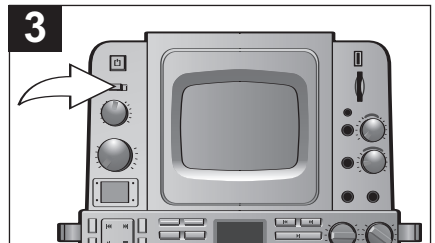

3 Slide the MONITOR switch to ON to view the On-Screen Graphics recorded on the CD+G disc on the monitor.

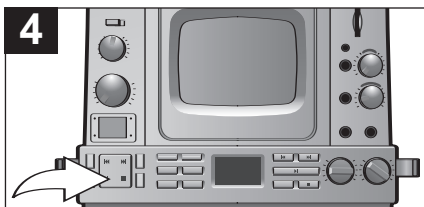

4 Press the CD+G PLAY/PAUSE (▶||) button to start CD+G playback; the PLAY/PAUSE and CD+G indicators will light.

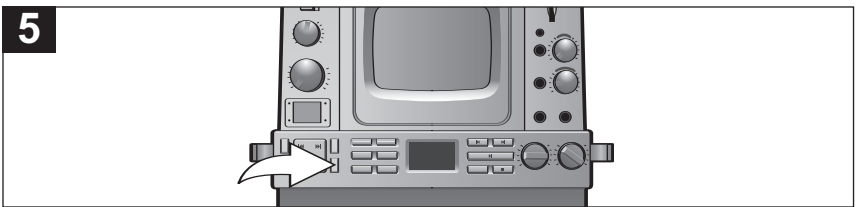

5 Press the VOCAL AUTO button to activate the Vocal Auto feature. When activated, the vocals on a multiplex recording are muted as soon as the singer begins singing into the microphone. When the singer stops singing, the vocals are automatically unmuted.
IMPORTANT NOTE: This feature only works with multiplex media.

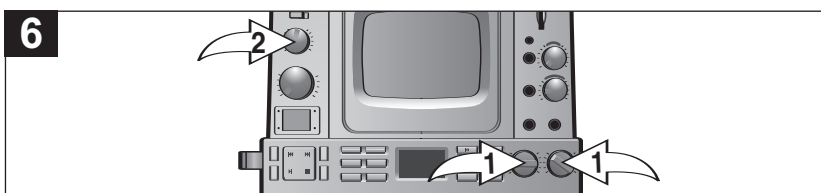

6 Adjust the MIC VOLUME control(s) ❶ as desired. Increasing these controls will increase the volume of the microphone(s). Adjust the ECHO control ❷ to add an echo effect to your voice. The ECHO control ❷ is variable so add as much or as little reverb as desired. Sing or talk into the microphone and you will hear both the CD+G and the microphone.

NOTES:

- The Program and Repeat features on a CD+G disc operate the same as with a standard CD.
- During playback of a CD+G disc, the CD+G indicator will light. During playback of a non-CD+G disc, the CD+G indicator will not light.

OPERATION (CONTINUED)

TO PLAY ALONG WITH A GUITAR

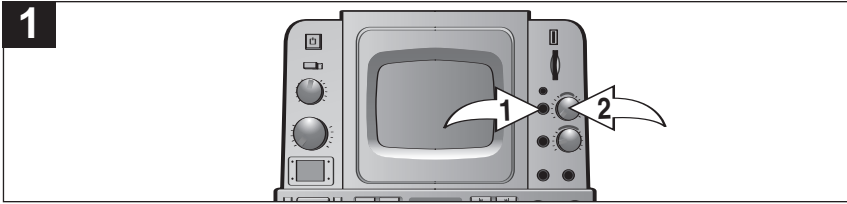

Plug in the guitar to the GUITAR jack ❶ and adjust the guitar volume with the GUITAR VOLUME control ❷.

TO PLAY ALONG WITH A KEYBOARD

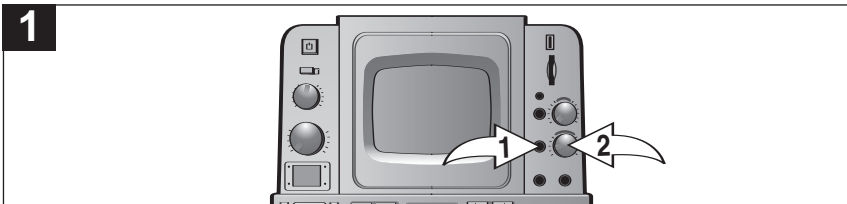

Plug in the keyboard to the KEYBOARD jack ❶ and adjust the keyboard volume with the KEYBOARD VOLUME control ❷.

INFORMATION ABOUT CD+G KARAOKE DISCS:

CD+G Karaoke discs are designed specifically for playback in special CD players that include a CD+G decoder, such as this unit. These discs contain the lyrics to each song and the lyrics will appear on your monitor and/or external TV screen, line by line, as the disc is playing. Usually the words on the screen will change color in time with the music to help you sing along at the proper tempo, even if you do not know the song.

Some CD+G Karaoke discs have all of the songs recorded twice, first with music only, and then with music and vocals together. (This type of recording is called a “Multiplex” recording.) For example, if you purchase a CD+G disc containing four songs, tracks one through four may have the music only without vocals, and tracks five through eight might have the same four songs recorded with music on the left channel and the vocal tracks on the right channel.

MICROPHONE FEEDBACK:

“Feedback” is a howling or screeching sound that occurs when the microphone(s) comes too close to the speaker. To avoid microphone feedback, keep the microphone(s) as far away from the speaker as the microphone cable(s) will allow. If you must bring the microphone(s) close to the speaker, such as when you are changing a disc or adjusting one of the other controls on the front of the unit, set the microphone(s) ON/OFF switch(es) to the OFF position.

OPERATION (CONTINUED)

PLAYING MP3/WMA FILES USING USB JACK AND/OR SD/MMC MEMORY CARD SLOT NORMAL PLAYBACK

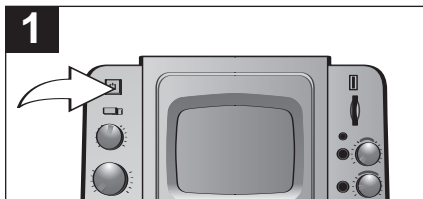

Press the POWER button to turn the unit on.

If no devices are connected to the USB jack or SD/MMC Memory Card slot yet, "NO DEV" will appear in the display.

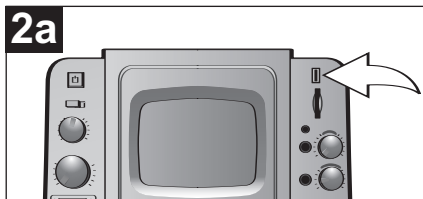

To use the USB jack, connect your player to the USB jack on this unit using the USB cable.

NOTES:

- The USB jack does not support iPod® models.
- Do not use a USB cable longer than 1 meter (approx. 3.3 feet) to connect to the USB jack.



To use the SD/MMC Memory Card slot, insert a 32MB to 1GB SD/MMC memory card into the slot as shown, until it clicks into place.

NOTE: If both media (USB and SD/MMC) are connected, this unit will default to the LAST inserted media. If this unit is turned off and then on with both media connected, this unit will default to USB.

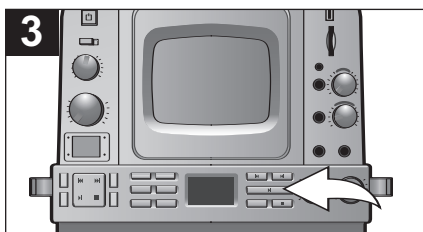

"USB" or "SD", the total number of files & "STOP" will appear in the display. Press the PLAY/PAUSE (▶||) button to begin playback; the current file and elapsed time will appear in the display. Also, the display will show the file format (i.e. MP3, WMA).

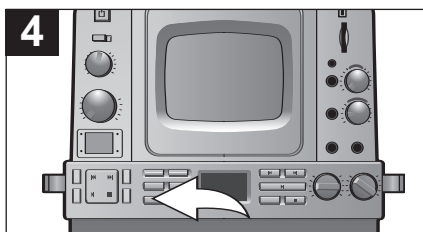

Press the DISPLAY button to view the folder/file name. Press again to resume viewing the current file and elapsed time.

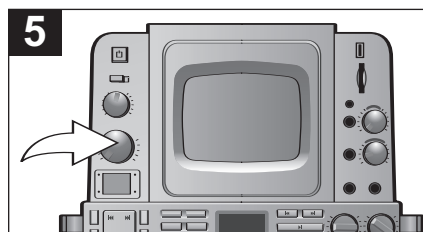

Adjust the MASTER VOLUME control as desired. Playback will continue until all of the files have been played.

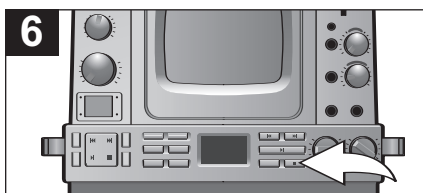

To stop playback, press the STOP (■) button. The disc will stop and the unit will be in Resume mode (meaning that if you press the PLAY/PAUSE (▶||) button, the unit will resume playback at the beginning of the last track that was playing). Press the STOP (■) button again to cancel Resume mode.

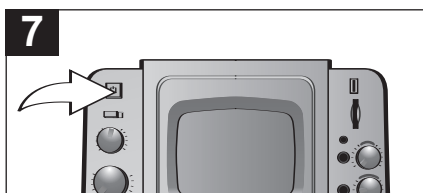

If you are finished listening, turn off and disconnect the player from the USB jack and/or remove the card from the SD/MMC Memory Card slot (push the edge of the card and the card will spring out). Then press the POWER button to turn the unit off.

NOTE:

- When formatting the player which you will connect to the USB jack or the SD/MMC memory card, use the FAT 32 format.
- When an MP3/WMA player (with an internal rechargeable battery) is connected to the USB jack and this unit is plugged in to the AC power source and turned on, the player will be charging.
- Please also read the "Connecting a Unit with Multiple Memories to the USB Jack" section on page 17.

OPERATION (CONTINUED)

PAUSE CONTROL

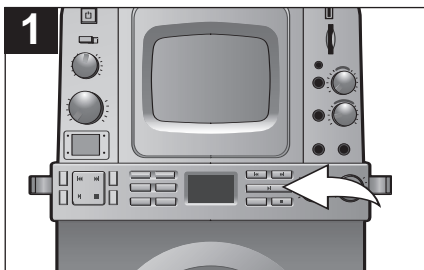

During playback, if you wish to pause playback momentarily, press the PLAY/PAUSE (▶||) button. Playback stops and the PLAY/PAUSE indicator in the display will blink.

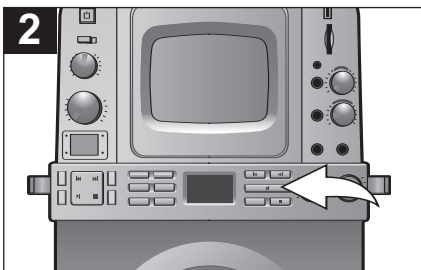

Press the PLAY/PAUSE (▶||) button again to release pause and resume normal playback; the PLAY/PAUSE indicator will stop blinking.

TO BEGIN PLAYBACK FROM A SPECIFIC FILE

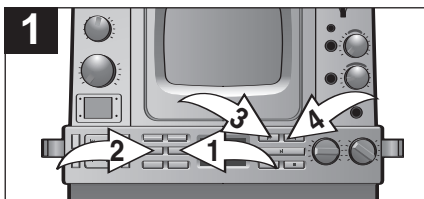

While in USB-SD/MMC Stop mode, use the DIR + ① and/or DIR - ② button to select a specific folder and SKIP/SEARCH ⏪ ③ or ⏩ ④ button to select a specific file for playback.

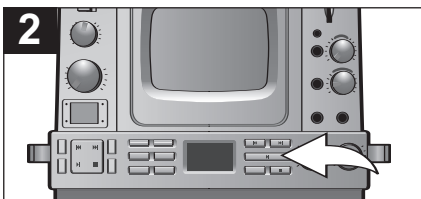

Press the PLAY/PAUSE (▶||) button. Playback will begin on the file you selected.

FORWARD/REVERSE SKIP AND HIGH-SPEED MUSIC SEARCH (⏩/⏪)

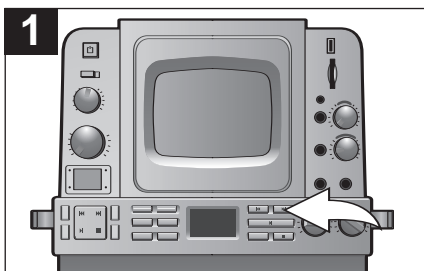

During playback, press the SKIP/SEARCH ⏩ button once to advance the player to the beginning of the next file. Press the SKIP/SEARCH ⏩ button repeatedly to advance the player to higher-numbered files.

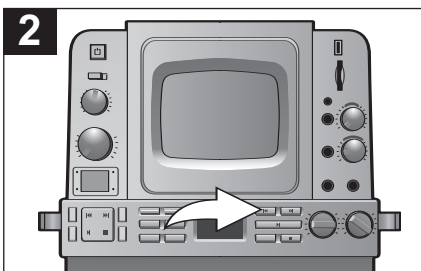





During playback, press the SKIP/SEARCH ⏪ button once to move the player back to the beginning of the current file. Press the SKIP/SEARCH ⏪ button repeatedly to move the player back to lower-numbered files.

3 During playback, press and hold either the SKIP/SEARCH ⏩ or ⏪ button to move the player forward or backward within a file to locate a specific musical passage. The player will move forward or backward at high speed as long as the button is depressed. When you release the SKIP/SEARCH ⏩ or ⏪ button, normal playback will resume.

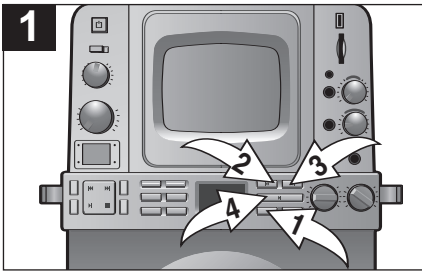

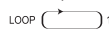
OPERATION (CONTINUED)

REPEAT PLAYBACK

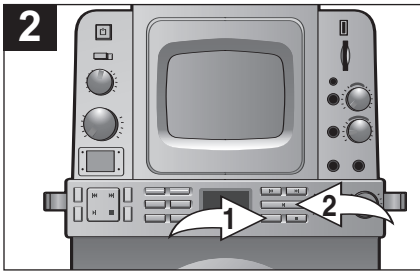

To repeat a single file, while in the USB-SD/MMC Stop mode, press the REPEAT button ❶ once; the Repeat One indicator  will appear in the display. Press the SKIP/SEARCH  or  button to select the specific file that you wish to repeat. Press the PLAY/PAUSE  button ❷ to begin playback. The specific file you selected will be repeated continuously.

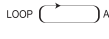

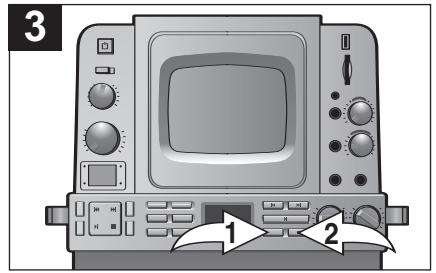

To repeat all of the files continuously, while in the Stop mode, press the REPEAT button ❶ twice; the Repeat All indicator  will appear in the display. Press the PLAY/PAUSE  button ❷ to repeat all tracks.

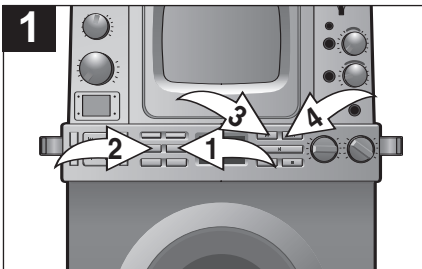

To cancel Repeat Playback, press the REPEAT button ❶ until the REPEAT indicators disappear from the display. You can also cancel Repeat Playback by pressing the STOP  button ❷.

DELETING A FILE



While in USB-SD/MMC Stop mode, use the DIR + ❶ and/or DIR - ❷ button to select a specific folder and SKIP/SEARCH  or  button to select a specific file to be deleted.

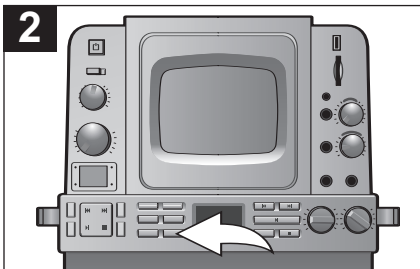

Then press the DELETE button. "DELETE?" will appear in the display. Within five seconds, press the DELETE button again to confirm deletion.

NOTES:

- **TO CANCEL FILE DELETION**, press the STOP  button when "DELETE?" appears in the display.
- While deleting, do not remove the player connected to the USB jack or the SD/MMC memory card from the unit. Otherwise, all files inside the storage device may be damaged.
- If you delete a middle recorded file, the files will not be resorted. For example, if there are ten total recorded files (LIVE001.MP3 to LIVE010.MP3), if you delete the fourth recording, a newly recorded file's number will be "LIVE011.MP3" when you record again.

OPERATION (CONTINUED)

USING THE RECORD AND RECORD SYNC FEATURES

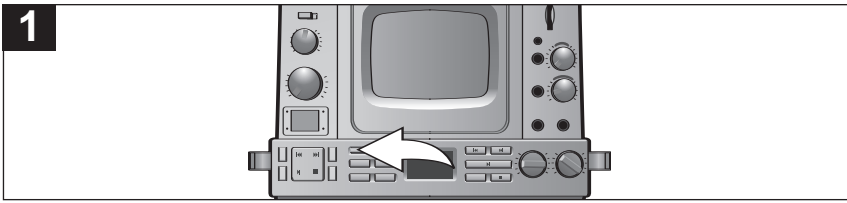

First connect and prepare the device(s) you want recorded (CD/CD+G, microphone(s), guitar and/or keyboard) as previously instructed.

Then, connect and prepare the device that you want to record to (player connected to the USB jack or SD/MMC memory card) as previously instructed.

To manually record, press the REC button; "REC" will appear in the display. The recorded file will be stored in the folder "LIVE_REC" with the name "LIVE001.MP3", LIVE002.MP3", up to "LIVE999.MP3".

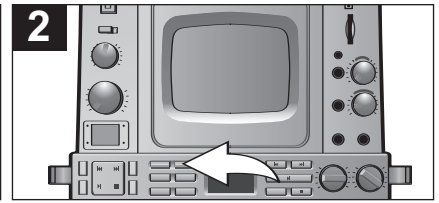

To synchronize recording, press the REC SYNC button; "REC" will blink and "SYNC" will appear in the display. Once any of the devices—CD/CD+G, mic(s), guitar and/or keyboard—are used, recording will automatically start and "REC" will stop blinking. The recorded file will be stored in the folder "LIVE_REC" with the name "LIVE001.MP3", LIVE002.MP3", up to "LIVE999.MP3".

NOTES:

- To stop recording (either method), press the STOP (■) button and wait for the display to show the total number of tracks. It may take a few minutes to finish the recorded file if the recording time is long.
- While recording, do not remove the player connected to the USB jack or the SD/MMC memory card from the unit. Otherwise, all files inside the storage device may be damaged.
- While recording, press the DISPLAY button to view the remaining time in the display. Press again to resume viewing the elapsed time.
- The display will show "USB FULL" if the USB memory is full, "SD FULL" if the SD/MMC memory is full or "TRK FULL" if there is a recorded file "LIVE999.MP3" stored in the player connected to the USB jack or the SD/MMC memory card.
- When the USB–SD/MMC display shows "TRK FULL", please move all recordings to your personal computer to make room for additional recordings.

CONNECTING A UNIT WITH MULTIPLE MEMORIES TO THE USB JACK:

If you connect a player to the USB jack with both internal memory and a SD/MMC memory card, press and hold the DIR + button for three seconds; the unit will read the SD/MMC memory card and the display will show "USB 02".

If you connect a unit with multiple memories to the USB jack (i.e., a unit with a card reader which has different cards [CF, memory stick, SD/MMC memory card, etc.]), press and hold the DIR + button again for three seconds; the unit will read the other card and the display will show "USB 03".

This unit can read up to nine memories via the USB jack (including the internal memory), but the sequence of the card reading is controlled by the card reader. To select the different cards inside the card reader, press the DIR + or DIR - button.

If the unit connected to the USB jack has an internal memory, it will be defaulted as "USB 01".

OPERATION (CONTINUED)

ADJUSTING THE PICTURE

When viewing the On-Screen Graphics recorded on the CD+G disc on the monitor, adjust the brightness, v-hold and contrast as follows:

V-HOLD



If the picture moves up and down or rolls, rotate to adjust the vertical hold.

CONTRAST

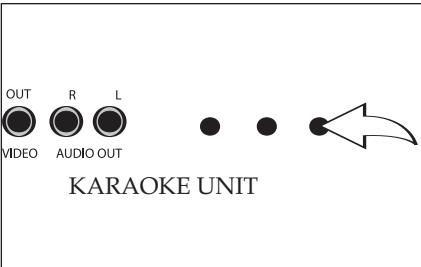

If the picture is too strong or too weak, rotate to adjust the contrast and clearly define the shades of blacks, grays and whites.

BRIGHTNESS

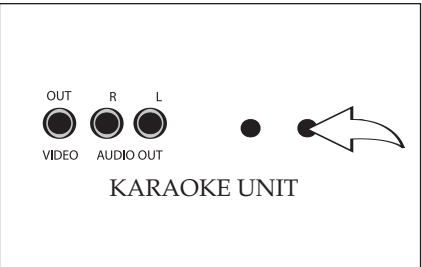

If the picture is too light or too dark, rotate to adjust the brightness.

CARE AND MAINTENANCE

Caring for Compact Discs

- Treat the compact disc carefully. Handle the compact disc only by its edges. Never allow your fingers to come in contact with the shiny, unprinted side of the compact disc.
- Do not attach adhesive tape, stickers, etc. to the compact disc label.
- Clean the compact disc periodically with a soft, lint-free, dry cloth. Never use detergents or abrasive cleaners to clean the compact disc. If necessary, use a CD cleaning kit.
- If a disc skips or gets stuck on a section of the compact disc, it is probably dirty or damaged (scratched).
- When cleaning the compact disc, wipe in straight lines from the center of the compact disc to the outer edge of the compact disc. Never wipe in circular motions.

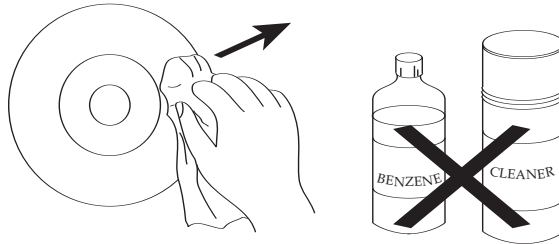
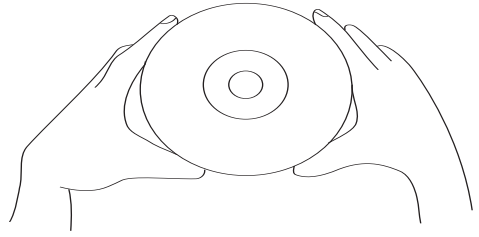

- This unit is designed to play only compact discs bearing the identification logos as shown here. Other discs may not conform to the CD standard and may not play properly.
- Compact Discs should be stored in their cases after each use to avoid damage.
- Do not expose compact discs to direct sunlight, high humidity, high temperatures or dust, etc. Prolonged exposure or extreme temperatures can warp the compact disc.
- Do not stick or write anything on either side of the compact disc. Sharp writing instruments, or the ink, may damage the surface.



Cleaning the Unit

- To prevent fire or shock hazard, disconnect your unit from the AC power source when cleaning.
- The finish on your unit may be cleaned with a dust cloth and cared for as other furniture. Use caution when cleaning and wiping the plastic parts.
- Mild soap and a damp cloth may be used on the front panel.

TROUBLESHOOTING GUIDE

Should this unit exhibit a problem, check the following before seeking service:

Symptom	Possible Cause	Solution
Compact Disc Player		
CD Player will not play.	CD is not installed or installed upside-down.	Insert CD with label side up.
CD skips while playing.	Disc is dirty or scratched.	Wipe disc with cloth or use another disc.
General		
No sound.	Power cord disconnected.	Connect power cord.
Karaoke		
Some vocals are still present when Vocal Auto feature is activated.	Backup vocals are supposed to be included.	This is normal; only the main vocal(s) are to be reduced.
Feedback is heard when singing.	Microphone is too close to unit or MIC volume is too high.	Move microphone away from unit or decrease MIC volume.
Words do not appear on monitor and/or TV.	Using non-CD+G disc.	Use CD+G disc.
	(FOR MONITOR) MONITOR switch set to OFF.	Set MONITOR switch to ON.
	(FOR TV) Video cable not connected properly to TV.	Check the connection as described on pages 5-6.
	(FOR TV) Source not selected on TV.	Change the TV video source to match the location of your karaoke machine connection. (i.e. VIDEO 1, AUX IN, etc.)
	A CD+G disc is playing but the CD+G indicator isn't on.	CD+G disc may need cleaning. (See CARE AND MAINTENANCE page 19.)
USB Jack and/or SD/MMC Memory Card		
External device will not play.	External device not connected properly.	Connect as described on page 14.
	Volume at minimum.	Increase volume.
Will not record to external device.	Device's memory is full.	Move all recordings to your personal computer to make room for additional recordings.

SPECIFICATIONS

GENERAL:

Power Source120V, 60Hz AC
Speaker4 ohms
Dimensions13 (W) X 19.75 (H) X 9.5 (D) Inches
Weight15.5 lbs
Output Power5 W

CD SECTION:

Disc Diameter4.72" (120mm)
.....3.15" (80mm) Single CD
Optical Source.....Semiconductor Laser
Wavelength780nm
D/A Conversion1-bit

USB JACK-SD/MMC MEMORY CARD SECTION:

File Support.....MP3: MPEG1/2/2.5 Layer 3
.....WMA
Bit RateMP3: 8-320kbps
.....WMA: 16-192kbps

Specifications are subject to change without notice.

FOR ADDITIONAL SET-UP OR OPERATING ASSISTANCE, PLEASE VISIT OUR WEBSITE AT
WWW.MEMOREXELECTRONICS.COM

OR CONTACT CUSTOMER SERVICE AT (954) 660-7100.

PLEASE KEEP ALL PACKAGING MATERIAL FOR AT LEAST 90 DAYS IN CASE YOU NEED TO
RETURN THIS PRODUCT TO YOUR PLACE OF PURCHASE OR TO MEMOREX.

FOR PARTS AND ACCESSORIES, CONTACT FOX INTERNATIONAL AT 1-800-321-6993.

Memcorp, Inc.
Weston, FL
Printed in Hong Kong

Visit our website at www.memorexelectronics.com